

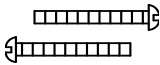



Fixture Name: Torbellino 8106-BA3 CDB

This fixture assembled PO: \_\_\_\_\_ Date: \_\_\_\_\_

**Notice:** Please review the parts listing and check for all parts before assembling the fixture. If any parts are missing or damaged, please note on this sheet and contact the place of purchase to arrange for replacement parts.

| <b>PARTS LIST</b>   |   | Company Name: _____ Co. Account #: _____<br>to be filled out by retailer   |  |
|---|---|--|--|
| Circular strap<br><br>1ea Φ102*1.5mm | Mounting screws<br><br>4ea 8/32T*1-1/4"L | Wire connencors<br><br>3ea Orange |  |
| Hex nut<br><br>2ea Φ9*3.5mm          | Deco nut<br><br>2ea Φ12*10hmm            | Finials<br><br>2ea Φ36*55hmm      |  |
| Part Needed _____   | Quantity _____  |  |  |
| Part Needed _____   | Quantity _____  |  |  |
| Reason why ( missing, scratched, broken glass, bent, bad finish)  |   |  |  |
| Comments _____  |   |  |  |

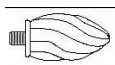
## FIXTURE ASSEMBLY INSTRUCTIONS

**Read and review installation instruction sheet before assembling the fixture.**

1. Attach the Finials(I) to each end of the bath bar(J) by twisting in a clockwise direction.
2. Place the Glass Shade(F) over the Socket (G).
3. Holding the Glass Shade(F), place the Socket Washer(I) over the Threaded Socket(G).
4. Secure Glass Shade(F) and Socket Washer (I) by threading the Socket Ring(H) onto the Threaded Socket(G) until tight.
5. Install the light bulb in accordance with the fixture's specifications.

(DO NOT EXCEED MAXIMUM WATTAGE RATING!)

**NOTE: INSTALL THE GLASS ASSEMBLY AFTER THE FIXTURE IS HUNG.**

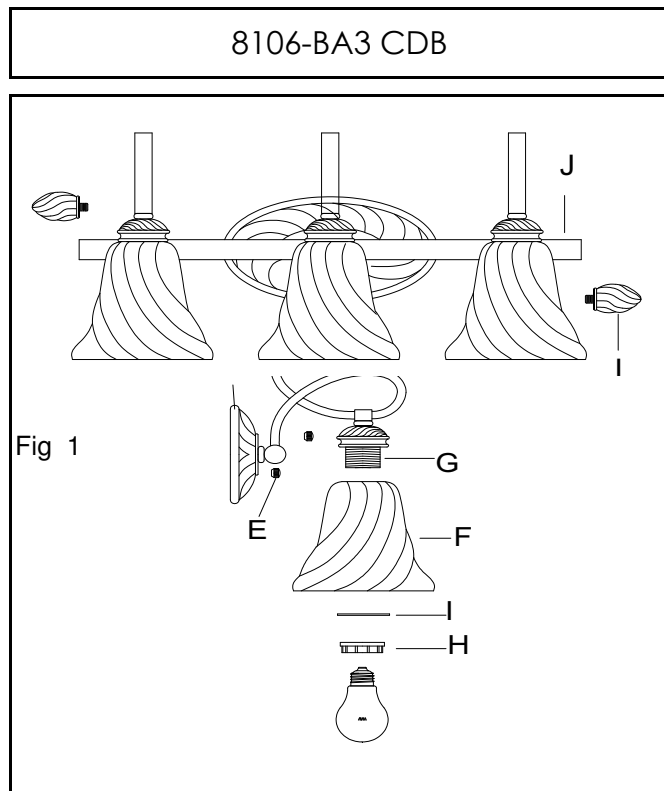

For Customer Service, contact the place of purchase to arrange for replacement parts.

Fixture Name: Torbellino 8106-BA3 CDB

For Wall Mount Light Fixture

## WARNING ! SHUT OFF POWER AT FUSE OR CIRCUIT BREAKER.

### HANGING THE FIXTURE (Fig.1)

1. Carefully remove the new fixture from the carton and the yellow bag that holds all your parts. Check that all parts are included as shown in the illustration and parts list.
2. Shut off power at the circuit breaker and remove the old fixture from wall, including the old mounting strap.
3. The Mounting Strap(A) contains several pairs of threaded holes, find the pair of holes that match the holes spacing in your fixture Back Plate(D) and thread the two Mounting Screws(C) half way into the Mounting Strap(A).
4. Place the Mounting Strap(A) over the Junction Box so the Mounting Screws(C) are vertical or horizontal, as required by fixture type.
5. Attach the Mounting Strap(A) to the Junction Box using the two mounting screws(B). Tighten the screws(B) securely with screw driver.

### CONNECTING THE WIRES (Fig 2)

6. Attach the power supply wires to the fixture lead wires by connecting BLACK to BLACK (or SMOOTH) and WHITE to WHITE (or RIBBED).
  7. Attach the GROUND wire(GREEN or COPPER) from the Junction Box and the fixture Ground wire to the green Ground Screw on the Mounting Bracket (B) or connect both wires together using the correct size of wire connectors.
- NOTE: Twist the wires together in the same direction you twist the wire connector onto the wires.
8. Tuck these wire connections neatly into the Junction Box.

### FINISHING THE INSTALLATION (Fig.3)

9. After tucking these wire connections neatly into the Junction Box and place the fixture Back Plate(D) over the two Mounting Screws(C) and secure the Back Plate(D) against the wall by threading two Deco Nuts(E) over the two Mounting Screws(C) until tight as shown on Fig.1.

YOUR INSTALLATION IS NOW COMPLETE.  
RETURN POWER TO THE JUNCTION BOX AND TEST THE FIXTURE.

Fig. 1

### JUNCTION BOX

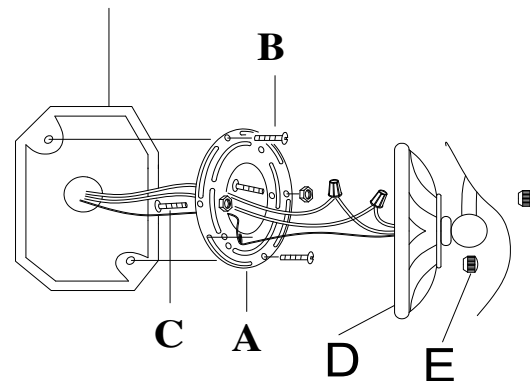

Fig. 2

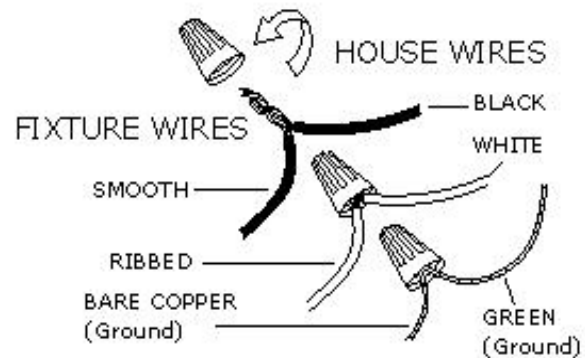

Fig. 3

